

Operation Manual for Perfect Binder

SPB-BM600

Details determine success or failure



Please read this manual carefully before using the machine

For reference only, information is subject to change without notice.

Edition: Second edition in June 2020

FOREWORD

Thank you for your selection for the intelligent wireless perfect binder. This manual is designed to help you to install, operate and maintain the perfect binder. Please read and understand this manual, and keep it in a safe and convenient place. With market as guide and technical force as backup, the series of perfect binder is an intelligent, practical and gas-electric integrated new product developed by the company with its abundant experience accumulated in many years. Each perfect binder was carried out strict quality management from design, development to purchase of materials, fully reflecting the company's aim of "Constantly Striving for Perfection and Making Customers Satisfactory".

The perfect binder possesses the characteristics of attractive appearance, simple operation, high efficiency etc., and is the optimal selection for binding books for graphic design and printing center, digital printing company, printing and packaging factory etc. Mapping out a strategy, gaining a decisive victory a thousand miles away---this product will help you set foot on the road to success!!!

CONTENTS

1. Overview.....	1
2. Safety Precautions.....	2
3. Machine Appearance And Parts Description.....	3-4
4. Parameters	5
5. Operation Panel.....	6
6. Operating Instructions.....	7-8
7. Touch Screen Operating Instructions.....	9-11
8. Function Introduction And Fine-Tuning Control Instructions.....	12-13
9. Binding Skills.....	14
10. Sensor error display.....	15
11. Electric Circuit	16
12. Warranty	17
13. Product Certificate	17
14. User Comment Form	18

1. Overview

1) .Machine Features

- a) Intergrated side glue function, make the glue more uniform, the adhesion is stronger, the book is more beautiful.
- b) Independent chip control, industrial grade thyristor, strong and weak electrical separation, faster response and more durable.
- c) Digital display for adjusting the book spine which is easier and more accurate.

2) .Scope of application

This product is suitable for graphic printing, design institute, small printing factory, office center.

3) .Use environment and working conditions

- a) Keep the work area clean and well ventilated
- b) The machine should be placed on a dry, clean and stable floor.
- c) There should be enough space on the front and rear of the machine for operation (do not place items on this machine).
- d) Prevent children and bystanders from approaching during operation, so as to avoid operator distraction and cause accidents.
- e) Please read the instructions carefully before using the tool.
- f) Always follow the instructions when using the machine.

4) .Protect the environment and save energy

- a) The hot melt adhesive used in the glue is mainly composed of EVA resin. Because it does not contain solvents, it does not pollute the environment and has high safety. Users can use it with confidence.
- b) Regular maintenance to keep the machine running properly and reduce noise pollution caused by frequent mechanical wear and tear.
- c) Keep the work room clean and dry, and clean up the paper scraps generated during work to avoid environmental pollution.
- d) After the machine stops working, please cut off the power in time.

2. Safety Precautions

When using the product, do not touch the glue tank which is hot ; not place other articles on the operating rail of the machine to avoid accident happening . When you use and carry out maintenance for it. the following safety items should be noticed.

 **Power supply:** Please refer to correct connecting method shown on the name plate on the side of the machine (if voltage was over-low or over-loading, it will lead to the machine operating abnormally);

 **Earthing:** In order to ensure your safety , please use power supply socket with earthing ;

 **Disassembly forbidden:** Forbid disassemble and modify machine without permission (if trouble happened, please switch off power supply, and make contact with local supplier so as to solve it properly). Before installing and debugging, must carefully read the instruction, familiarize yourself with the requirements of operating the machine;

 **Clean and maintenance:** Before clean or maintenance, you must switch off power supply.

 **Equipment scrap:** If the equipment is to be scrapped, please send it to a professional institution for disposal in accordance with relevant standards, and do not throw it away at will.

3. Appearance of the machine

open box to check

Open package for check
Open external package,
first check accessories
attached with the equipment,
if having damage or being
incomplete, please make
contact with supplier or our
factory.



- | | |
|-------------------------|------------|
| 1. Main machine | one unit; |
| 2. Operation manual | one piece; |
| 3. Brush | one piece; |
| 4. Small milling cutter | one piece; |
| 5. Power supply wire | one piece; |
| 6. Toolkit | some; |
| 7. Spine glue | one bag; |
| 8. Operation sticker | one piece; |
| 9. Warranty card | one set |

TIPS

For each rotation, the sliding mechanism should be lubricated regularly (monthly).

4. Parts Descriptions

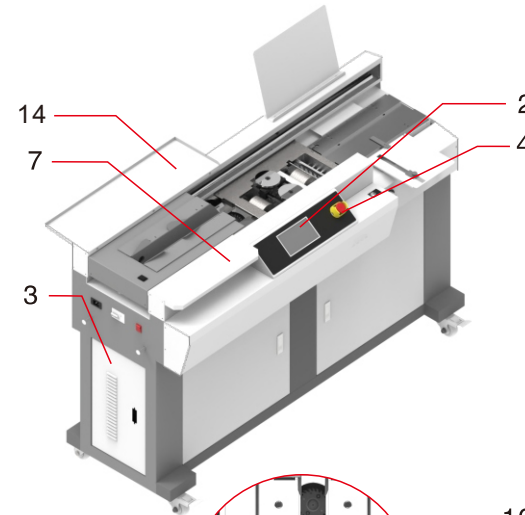

1. Cover rest plate
2. Operation panel
3. Electric control cabinet
4. Emergency stop switch
5. Carriage clamp switch
6. Carriage clamp
7. Book support plate

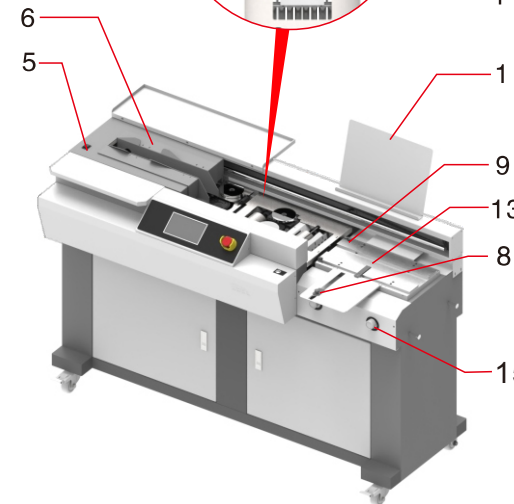
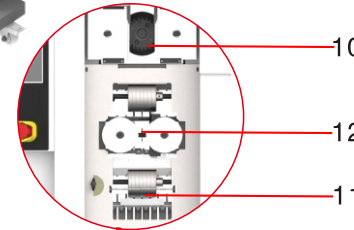

8. Cover scale
9. Cover sensor
10. Sun milling cutter
+ Small milling cutter
11. Spine glue roller
12. Side glue roller
13. Cover clamping platform
14. Book rest plate
15. Adjust knob for spine angle

5. Introduction

5.1 Parameters

Model	SPB-BM600
Binding length	16.5 inch
Binding thickness	2.4 inch
Binding speed	300 books/hr
Glue melt time	Less than 50 min
Milling mode	Sun milling cutter + Small milling
Book clamping mode	Electric
Cover clamping	Single motor
Gluing mode	Double glue rollers + side glue roller
Milling fold	Tri-fold
Cover platform	uncovered
Carriage clamp	Linear guide
Cover clamping	Vertical
Power supply	110V/60HZ/2000W
Machine weight	694 lbs
Machine dimension	63*23*41 inch

As a result of technical improvement, some parameters may be slightly different from the ones above, which does not affect your normal use.

5.2 Operation Panel

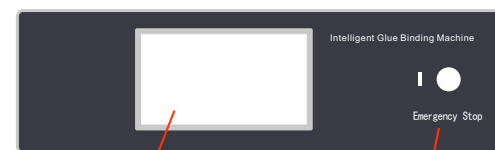

Touch screen

Emergency stop switch

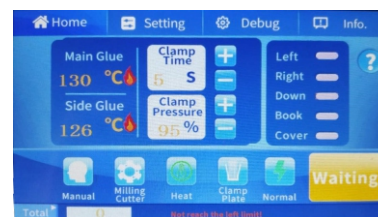

Main interface

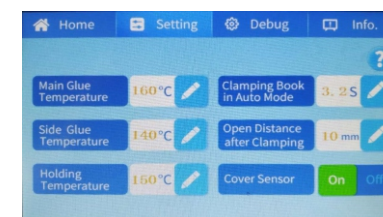

Parameter setting

Parameter setting instructions

- 1.1 Main glue temperature is used to set the melting temperature of glue in the main glue tank.
- 1.2 Holding temperature is used to set the temperature of the main glue tank and side glue tank to maintain the glue capacity and not harden.
- 1.3 Automatic Mode Book Hold Time is used to set the waiting time for the carriage to hold the book in the automatic mode.
- 1.4 Opening distance after book clamping is used to set the gap between the book and the book clamping device after the carriage goes to the right end, the carriage is opened.
- 1.5 The "cover sensor" is generally in the "on" state. Once there is a problem with the cover sensor, you can switch to the "disabled" state to ensure that the machine can continue to bind the book.

6. Operation Instruction

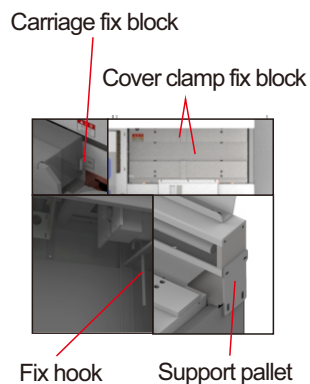

Figure 1

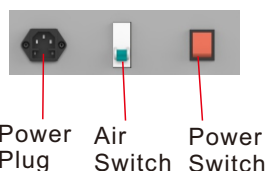

Figure 2

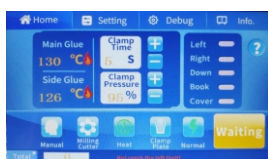

Figure 3

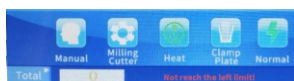

Figure 4

6.1 Preparation before binding

- 6.1.1. Remove the carriage fixing block and cover plate fixing block, and remove the fixing hook inside and support pallet. As figure 1, install the cover pallet, book support plate and shelf.
- 6.1.2. Check the power connection, turn on the air switch and power switch to allow the machine to heat up normally only after confirming it is correct.

(The warm-up time is about 40 minutes. After the warm-up is completed, the flame on the surface turns green, and the status area shows "Ready" then you can start to do the binding.) As shown in Figure 2 and 3.

6.2. Manual Binding Mode

- 6.2.1. The current setting to "Manual" mode
- 6.2.2. The cutter status: "Cutter" button turns green, indicating that the cutter is enabled; white means that the cutter is disabled
- 6.2.3. The "Cover Clamp" button turns green, which means that the cover clamp is working, otherwise it does not work. As shown in Figure 4
- 6.2.4. Set the binding mode to "Standard"; set to "Hold" to make the glue tank heating, a green flame shows that has reached the binding temperature
- 6.2.5. Place the book cover on the cover platform according to the requirements; organize the book, press the switch to clamp the book
- 6.2.6. After the prompt bar says "Ready", press the "Start" button
- 6.2.7. When the binding is completed and the carriage is opened, draw the book to the right side
- 6.2.8. Observe the binding effect, whether the glue thickness and the corner angle meet the requirements. If need to adjust, finely adjust the platform through the angle adjustment knob, and adjust the glue thickness through the glue layer adjustment knob. As shown in Figure 5 and 6.

6.3 Automatic binding mode (As shown in Figure 7)

- 6.3.1 The current setting to "Automatic" mode
- 6.3.2 The cutter status: "Cutter" button turns green, indicating that the cutter is enabled; white means that the cutter is disabled
- 6.3.3 The "Cover Clamp" button turns green, which means that the cover clamp is working, otherwise it does not work
- 6.3.4 Set the binding mode to "Standard"; set to "Hold" to make the glue tank heating, a green flame shows that has reached the binding temperature
- 6.3.5 Place the book cover on the cover platform according to the requirements; organize the book, put into the book clamp
- 6.3.6 Hold the book and wait for 2 seconds until the book clamp is automatically clamped and the binding is performed automatically
- 6.3.7 When the binding is completed and the carriage is opened, draw the book to the right side
- 6.3.8 Observe the binding effect, whether the glue thickness and the corner angle meet the requirements. If need to adjust, finely adjust the platform through the angle adjustment knob, and adjust the glue thickness through the glue layer adjustment knob; continue to work and repeat steps 6.3.1-6.3.8



Figure 5

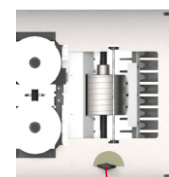

Figure 6

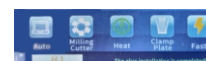

Figure 7

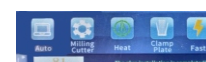

Figure 8

6.4 Fast binding mode (As shown in Figure 8)

- 6.4.1 Choose "Auto" mode or "Manual" mode
- 6.4.2 The cutter status: "Cutter" button turns green, indicating that the cutter is enabled; white means that the cutter is disabled
- 6.4.3 The "Cover Clamp" button turns green, which means that the cover clamp is working, otherwise it does not work
- 6.4.4 Set the binding mode to "Fast" mode, which means that after the carriage is at the right end, the cover platform is clamped, the carriage is opened, the users do not have to take the book, the carriage will automatically returns to the left end
- 6.4.5 Set to "Heat" to make the glue tank heating, a green flame shows that has reached the binding temperature
- 6.4.6 Place the book cover on the cover platform according to the requirements; organize the book, put into the book clamp
- 6.4.7 The rest of the operation is the same as manual mode or automatic mode.

KINDLY PROMPT

In the course of using the perfect binder, you will accumulate many practical experiences, welcome to communicate with our company so as to let more users to be beneficial.

7.Touch Screen Operating Instructions

7.1 Interface description

After the system is powered on and initialized, enter the main control interface

Areas: function status bar, system parameter bar, sensor status bar. As shown in Figure 9

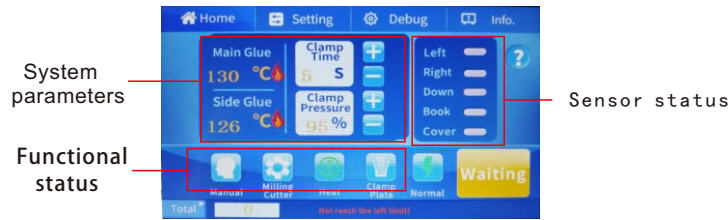

Figure 9

7.1.1 When the user clicks on the parameter setting in the menu bar, the screen will switch to the parameter setting interface. When displays the parameters that can be set, mainly including the main glue temperature, side glue temperature, cover clamp platform height, clamping time and clamping pressure, as shown in Figure 10

7.1.1.1 Set temperature: Set the glue tank heating temperature. Click on the main glue temperature to pop up the input box, after setting the main glue temperature, press the Enter key to save automatically.

7.1.1.2 Clamping time: set the time of the clamping cover, set the required time by clicking - & +.

7.1.1.3 Clamping pressure: set the pressure of the clamping cover, operation mode is same as clamping time setting.

7.1.1.4 Binding mode:

Fast binding-the carriage works normally to the right end. After finishing the cover clamping, the carriage automatically opens and resets to the left end.

Standard binding-The carriage works normally to the right end, after finishing the cover clamping, need to manually take out the book, the carriage will reset to the left end.

The total number includes: total number of binding, positive count, count down.

Number of books: When doing positive counting, the number of books is the number of books that have been finished.

As shown in Figure 11.

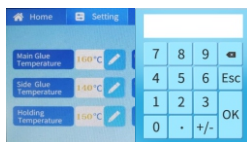

Figure 10

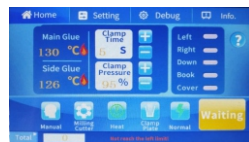

Figure 11

7.1.2 The sensor status bar mainly displays the status of each sensor, that is, whether each state is detected by the sensor. As shown in Figure 12.

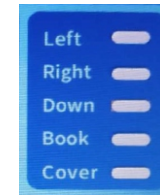

Figure 12

7.1.3 Function status bar: mainly divided into automatic, manual, heat preservation, heating, milling cutter is selected, milling cutter is not selected, the cover clamp is raised, the cover clamp is not raised, fast and standard. The state of binding is divided into two states: "automatic binding" and "manual binding". By press the binding state area can switch between two states. If the current binding status is "manual binding", then after clicking, the state of the glue binding changes to "automatic binding"; if the current state of glue binding is "automatic binding" then after clicking, the state will change to "manual binding".

As shown in Figure 13, the icon for automatic binding

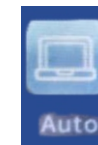

Figure 13

7.1.4 The state of glue heating / insulation is divided into two states: "heating" and "holding". You can switch between these two states by tapping on the holding state area. If the current glue status is "heating", then the state of the glue changes to "holding" after clicking.

The glue state is "holding", then after the clicking, the glue state becomes "heating". As shown in Figure 14, the glue is heated.



Figure 14

7.1.5 The status of the milling cutter is divided into "able" and "disable". By touching the icon of the milling cutter, the state area can switch between these two states. The "Cutter" button turns green, indicating that the cutter is working, white means that the milling cutter is disabled; if the current milling cutter is in the "used" state, then after clicking, the cutter status becomes "disabled".

7.1.6 The cover clamp status is in "open" mode and "disabled" mode. When the cover clamp icon is green which means is the normal working mode, and the clamping platform will trigger the clamping action. When the cover clamp icon is white which means the cover clamping mode is disabled. At this time, the cover clamp platform does not move when the book is formed, that is, only with main glue and side glue and without cover.

7.1.7 If the melting in the glue tank is not completed, the start button displays "waiting". When the melting is completed, "Start" is displayed.



7.2 Engineering mode

7.2.1 Enter engineering mode

7.2.2 Click "Engineering Mode"

7.2.3 Click the yellow input box, the keyboard appears on the right side. Enter the password 1234 and click "OK"

7.2.4 Click the "OK" button to enter the engineering mode

7.2.5 Click the "Up" button to turn green, the cover clamp platform is raised, and then click to close the cover clamp platform motor

7.2.6 Click the "Down" button to turn green, the cover clamp platform drops, and then click to close the cover clamp platform motor

7.2.7 Click the "Left" button to turn green, the carriage will go to the left end, and then click to turn off the carriage motor

7.2.8 Click the "Right" button to turn green, the carriage will go to the right end, and then click to turn off the carriage motor

7.2.9 Click the "Cutter" button to turn green, turn on the cutter motor, and then click to turn off the cutter

7.2.10 Click the "Clamp" button to turn green, turn on the roller motor, and then click to close the roller

7.2.11 Click the "heat" button to turn green, the heating tube can heat the glue; then click the button to switch back to the blue button, the glue stops heating

7.2.12 Click the "Home" button, the user returns to the main interface

8. Function Introduction And Fine-Tuning Control Instructions

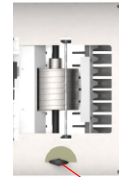

Figure 15

Adhesive layer thickness 7-step adjustment knob

1. Knob-type glue adjusting handle
As shown in Figure 15, the arrow points to the left side is the smallest, the glue layer is the most thin; on the contrary, the arrow points to the right side, the glue layer is the thickest

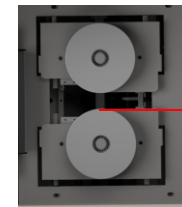

Figure 16

Side glue

2. Side glue device
As shown in Figure 16, with the side glue, the glue is firmer, not easy to drop pages, the fold lines are neat, and the cover is more beautiful.

3. 7-inch touch screen .
Uses a 7-inch smart large screen. Display more clearly. Operation more convenient. Such as: Figure 17

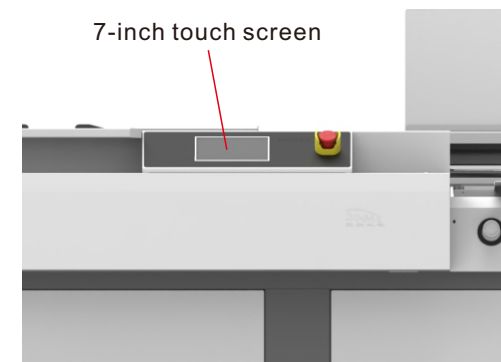

Figure 17

4. Adjusting spine angle function

Turn the adjust knob for spine angle, can quickly and easily adjust the spine angle for better binding.
As shown in Figure 18

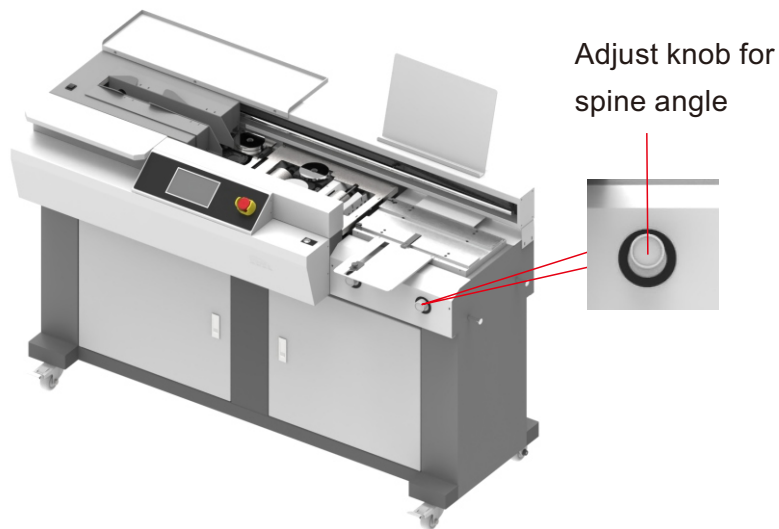

Figure 18

9. Binding Skills

If you are not familiar with the performance of the perfect binder, you may meet many problems in the course of binding books, such as spine wrinkling, gluing not enough, spine's both ends with square head at one end and round head at another end etc., hereby hope that you can communicate with us more to richen your binding book experiences and improve binding quality and binding speed.

1. After book being binded and cooled down, book pages are easy separated and scatter, cover glue being not firm, or glue thickness being not uniform, etc.
Method: check if the whole part of the glue tank is over-high, causing the gap between spine and roller wheel to be smaller, thus affecting gluing quality; aiming at this condition, adjust glue tank height; generally the gap between roller wheel and spine is about 2.5 mm.

2. Spine wrinkling or too much glue at edges, book spine with square head at one end and round head at another end.

Method: the above phenomenon can be adjusted through adjusting height of cover clamping platform.

3. If inner fold face of binding book failed to be milled.

Method: the requirement of milling depth can be reached through adjusting the height of milling cutter; adjusting scope of milling cutter: 0-1.5 mm.

4. How to bind hardcover.

Method: as hardcover is a special thick cover, it needs secondary gluing.

When first gluing, do not place cover on cover clamping platform, but cover clamping platform and both clampers need to be coated with proper white oil (sewing machine oil), book block are clamped, milling the book spine and gluing, then to be clamped (without cover). When second gluing, place glued book block on carriage clamp and place thick cover on cover clamping platform; adjust clamping pressure to position 50, second gluing, lifting cover clamping platform and keep such state for a certain time, then open carriage clamp and take out book.

5. How to bind financial instruments.

Method: as financial paper bills are very thin, pages are difficult to be processed tidy. Thus first cut the end which needed to be binded, then carry out for binding.

10. Sensor error display

If the machine is faulty during operation, an alarm sounds, please check whether the corresponding sensor indicator on the display lights red, and check the fault according to the following.

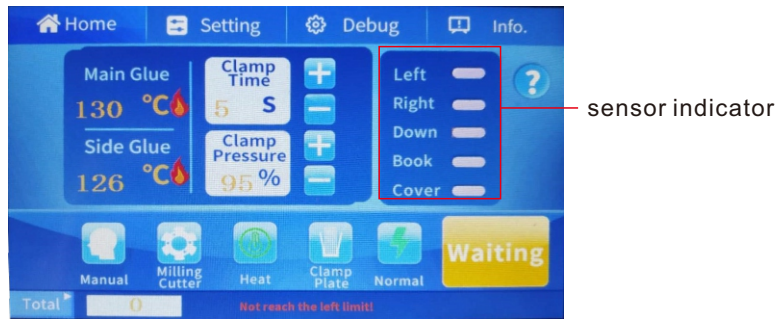

Display	Fault	Solutions
The left limit light turns on red	The left limit sensor is faulty.	The sensor is off or displaced; The sensor wiring is shorted or damaged; The related parts of the motherboard are faulty.
The right limit light turns on red	The right limit sensor is faulty.	
The lower limit light turns on red	The lower limit sensor is faulty.	
The cover light turns on red	The cover sensor is faulty.	The cover is not placed properly, the sensor surface is dusty; Short circuit or damage to the cover-sensing wire; The relevant parts of the motherboard are faulty
The book block lamp light turns on red	The book block sensor is faulty.	The book block is not placed properly, and the surface of the book block sensor is dusty; The wiring of the book block sensor is shorted or damaged; The relevant parts of the motherboard are faulty

11. Electric Circuit

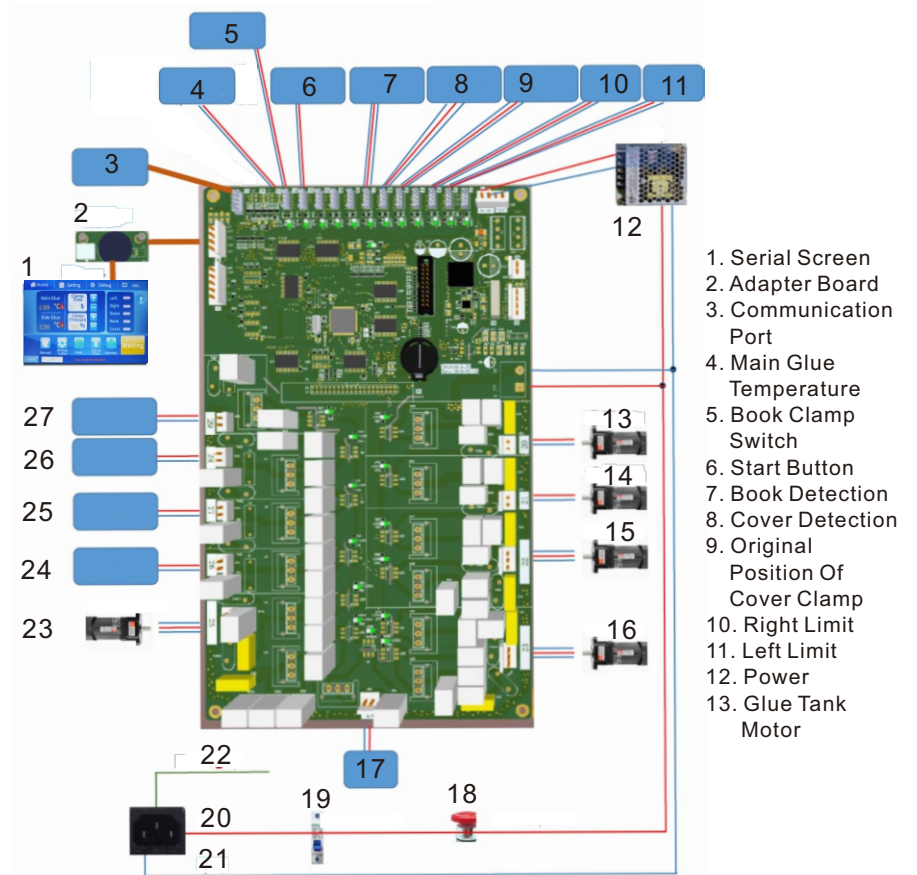

14. Milling Cutter Motor 15. Book Clamp Motor 16. Cover Clamp Motor 17. Brake
 18. Emergency Stop Button 19. Leakage Protection Air Switch 20. Fire Wire
 21. Zero Wire 22. Ground Wire 23. Carriage Clamp Drive Motor
 24. Glue heating 1 25. Glue heating 2 26. Glue heating 3 27. Glue heating 4

12. Warranty

From machine purchasing date, the following regulations belong to the scope of guarantee:

1. Mechanical part: one year guarantee;
2. Electric circuit and parts: free repair within a year;
3. Motor: free repair within six months;
4. Sensor: free repair within 3 months;

Note: During guarantee term, traveling expenses are not included.

The following conditions do not belong to guarantee scope; users must pay for maintenance and parts fees:

1. No company's maintenance mark;
2. Trouble was caused from irregular operation or malicious damage;
3. Trouble of electronic components caused from oil or water entering into the machine;
4. Trouble of electric part caused from voltage instability;
5. The machine was damaged due to other impurities entering into the machine;
6. The machine was repaired by maintenance station unauthorized by the company or using the materials and parts not stipulated by the company;
7. Consumables: brush, sun milling cutter, small milling cutter, switch, heater.

13. Machine Inspection Conformity Certificate

Machine Description	Intelligent Glue Binding Machine
Model	
Class	
Inspector	
Inspection date	

14. Users Opinions

Manufacturer	
Model	
Production Date	
Machine S/N.	
User	
Address	
Tel.	
Phenomena appeared:	
Opinion and suggest:	